



5SDF 08T4505

Old part no. DM 818C-800-45

Fast Recovery Diode

Properties

- Optimized recovery characteristics
- Industry standard housing

Applications

- suited for GTO applications
- Snubber diode
- Freewheeling diode

Key Parameters

V_{RRM}	=	4 500	V
I_{FAVm}	=	767	A
I_{FSM}	=	15 000	A
V_{TO}	=	1.807	V
r_T	=	0.735	mΩ

Types

	V_{RRM}
5SDF 08T4505	4 500 V
Conditions: $T_j = -40 \div 125$ °C, half sine waveform, $f = 50$ Hz	

Mechanical Data

F_m	Mounting force	22 ± 2 kN
m	Weight	0.44 kg
D_s	Surface creepage distance	22 mm
D_a	Air strike distance	14 mm

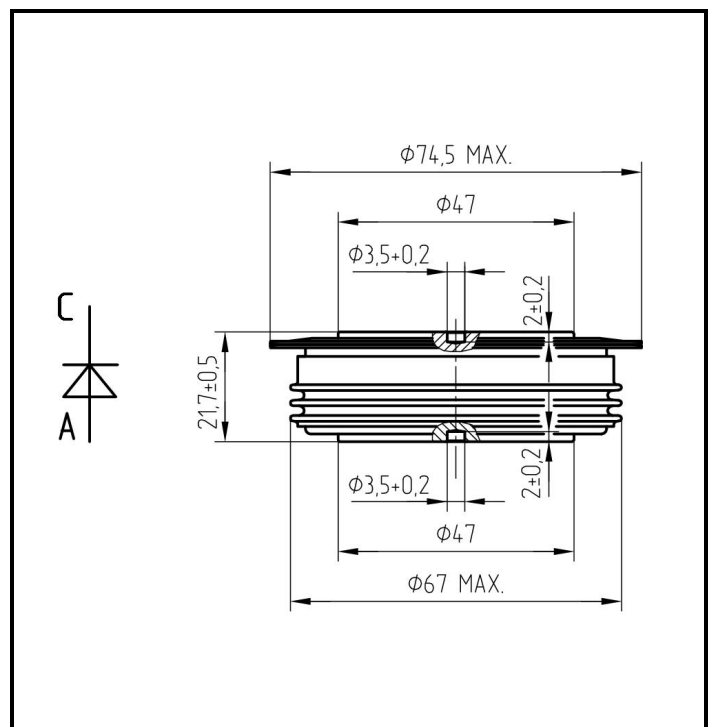


Fig. 1 Case



ABB s.r.o.

Novodvorska 1768/138a, 142 21 Praha 4, Czech Republic

tel.: +420 261 306 250, <http://www.abb.com/semiconductors>

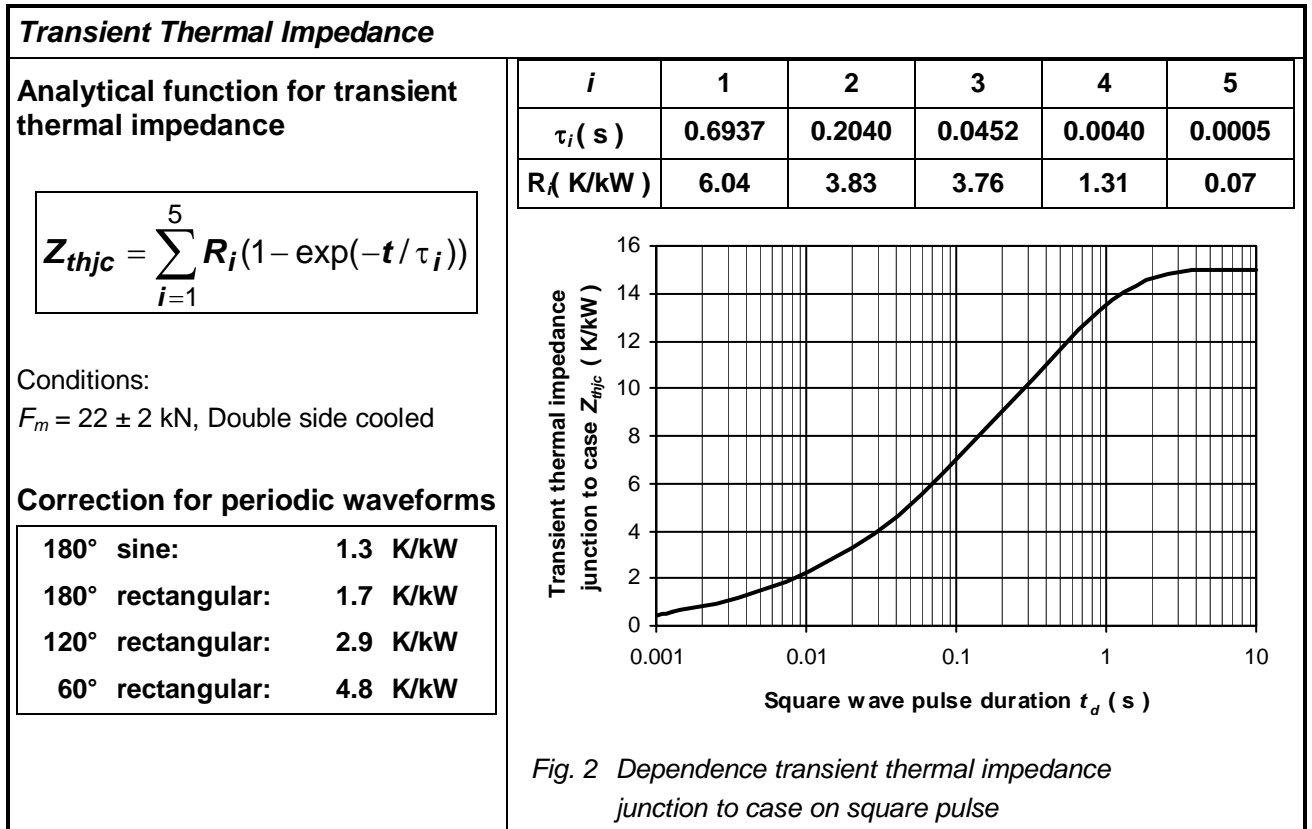
Maximum Ratings		Maximum Limits	Unit	
V_{RRM}	Repetitive peak reverse voltage $T_j = -40 \div 125 \text{ }^\circ\text{C}$	4 500	V	
I_{FAVm}	Average forward current $T_c = 85 \text{ }^\circ\text{C}$	767	A	
I_{FRMS}	RMS forward current $T_c = 85 \text{ }^\circ\text{C}$	1 205	A	
I_{RRM}	Repetitive reverse current $V_R = V_{RRM}$	50	mA	
I_{FSM}	Non repetitive peak surge current $V_R = 0 \text{ V, half sine pulse}$	$t_p = 8.3 \text{ ms}$	16 000	A
		$t_p = 10 \text{ ms}$	15 000	A
I^2t	Limiting load integral $V_R = 0 \text{ V, half sine pulse}$	$t_p = 8.3 \text{ ms}$	1 066 000	A²s
		$t_p = 10 \text{ ms}$	1 125 000	A²s
$T_{jmin} - T_{jmax}$	Operating temperature range	-40 ÷ 125	°C	
T_{STG}	Storage temperature range	-40 ÷ 125	°C	

Unless otherwise specified $T_j = 125 \text{ }^\circ\text{C}$

Characteristics		Value			Unit
		min	typ	max	
V_{T0}	Threshold voltage			1.807	V
r_T	Forward slope resistance $I_{F1} = 1\,257\text{ A}, I_{F2} = 3\,770\text{ A}$			0.735	m Ω
V_{FM}	Maximum forward voltage $I_{FM} = 2\,000\text{ A}$			3.310	V
Q_{rr}	Recovered charge $V_R = 100\text{ V}, I_{FM} = 1000\text{ A}, di/dt = -80\text{ A}/\mu\text{s}$		500	700	μC
I_{rrM}	Reverse recovery maximum current <i>the same conditions as at Q_{rr}</i>		160	230	A
t_{rr}	Reverse recovery time <i>the same conditions as at Q_{rr}</i>			5.0	μs
S	Soft factor, $S = t_s / t_f$ $I_{FM} = 1\,000\text{ A}, di_f/dt = -200\text{ A}/\mu\text{s}, V_R = 400\text{ V}$		2.0		-
I_{rrM}	Reverse recovery maximum current <i>the same conditions as at S</i>			400	A
V_{rrM}	Reverse recovery maximum voltage <i>the same conditions as at S</i>			1 100	V

Unless otherwise specified $T_j = 125\text{ }^\circ\text{C}$

Thermal Parameters			Value	Unit
R_{thjc}	Thermal resistance junction to case	double side cooling	15	K/kW
		anode side cooling	24	
		cathode side cooling	40	
R_{thch}	Thermal resistance case to heatsink	double side cooling	4	K/kW
		single side cooling	8	



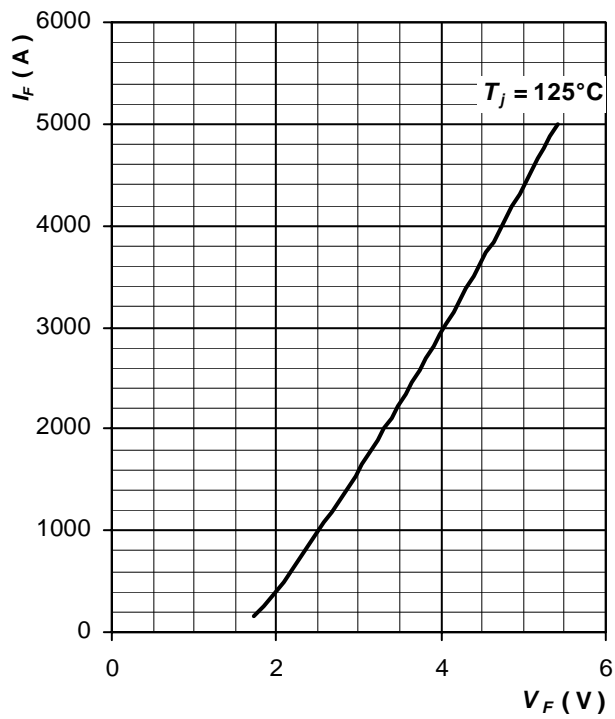
Forward Characteristics

Fig. 3 Maximum forward voltage drop characteristics

Surge Characteristics

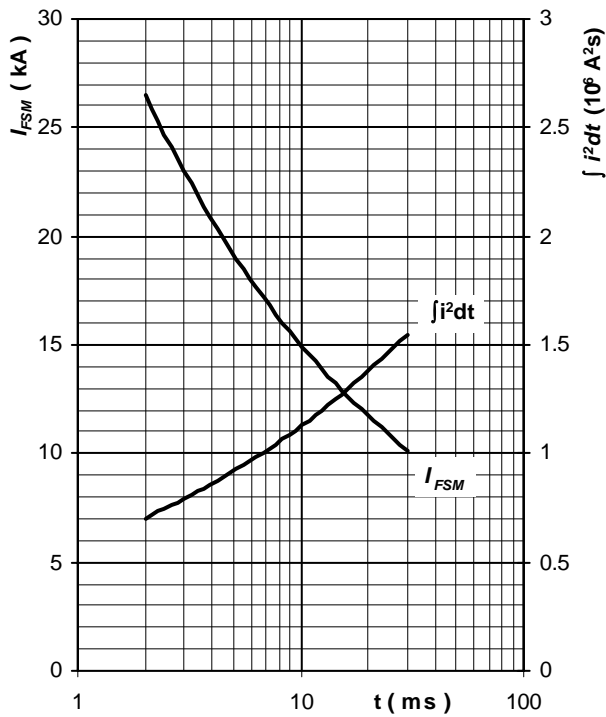


Fig. 4 Surge forward current vs. pulse length, half sine wave, single pulse, $V_R = 0 V$, $T_j = T_{jmax}$

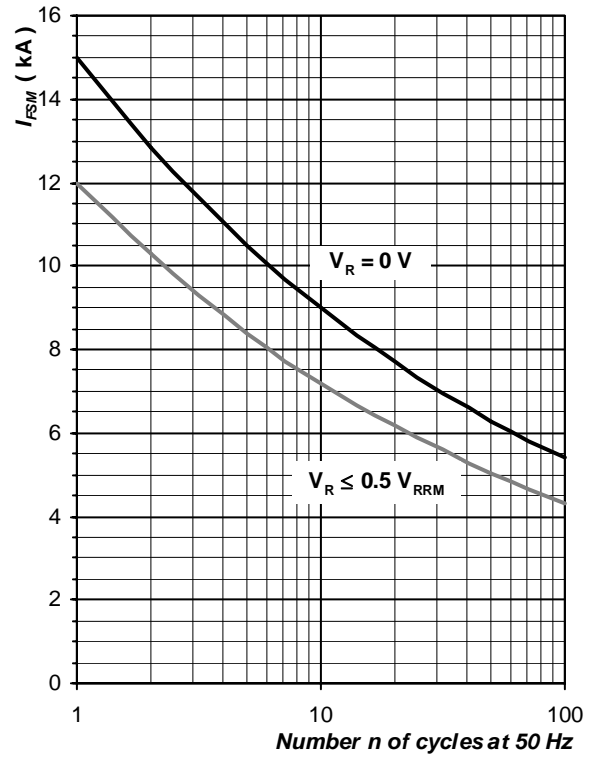


Fig. 5 Surge forward current vs. number of pulses, half sine wave, $T_j = T_{jmax}$

Power Loss and Maximum Case Temperature Characteristics

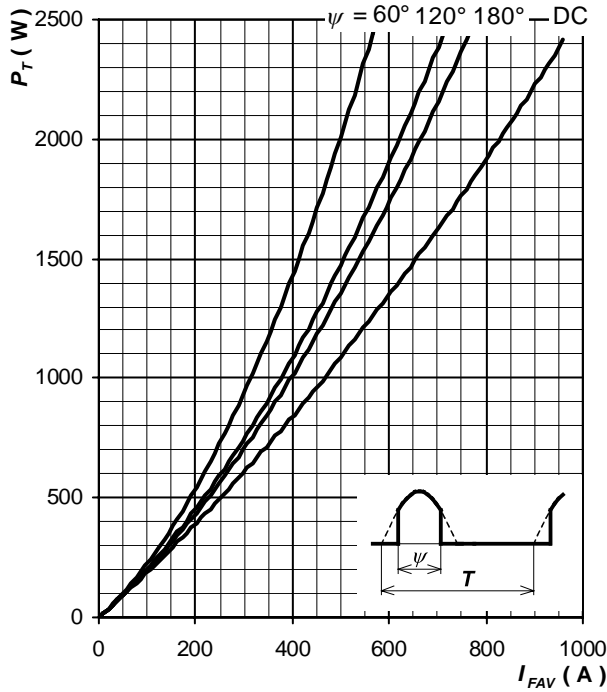


Fig. 6 Forward power loss vs. average forward current, sine waveform, $f = 50 \text{ Hz}$, $T = 1/f$

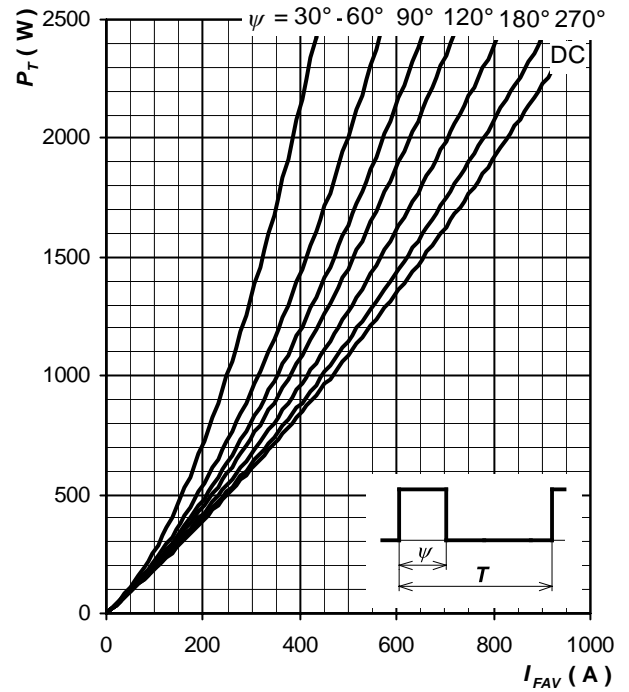


Fig. 7 Forward power loss vs. average forward current, square waveform, $f = 50 \text{ Hz}$, $T = 1/f$

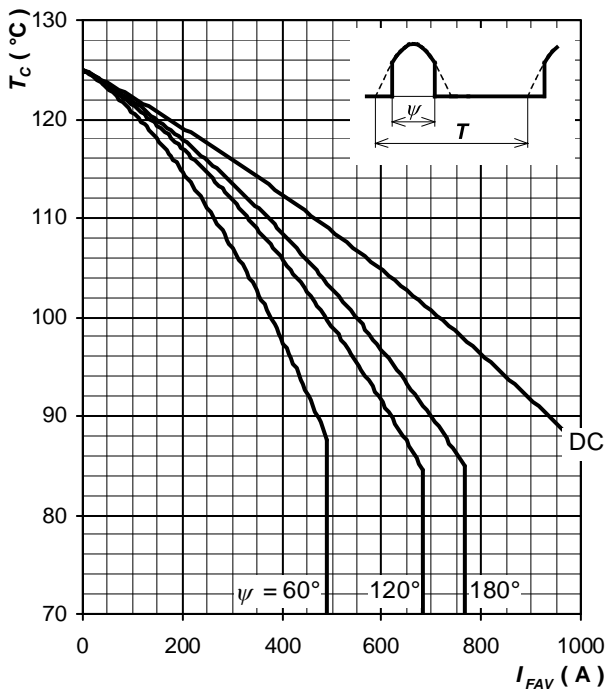


Fig. 8 Max. case temperature vs. aver. forward current, sine waveform, $f = 50 \text{ Hz}$, $T = 1/f$

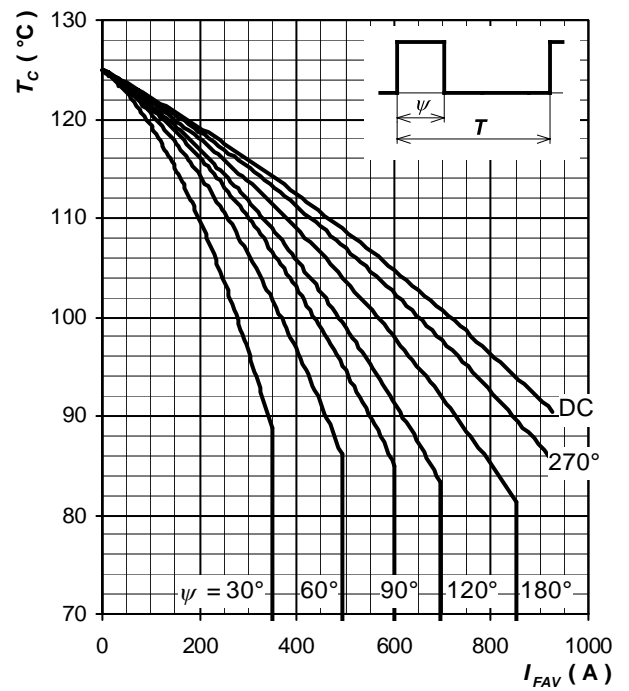


Fig. 9 Max. case temperature vs. aver. forward current, square waveform, $f = 50 \text{ Hz}$, $T = 1/f$

Note 2: Figures number 6 ÷ 9 have been calculated without considering any forward and reverse recovery losses. They are valid for $f = 50$ or 60 Hz operation.

Forward Recovery Characteristics

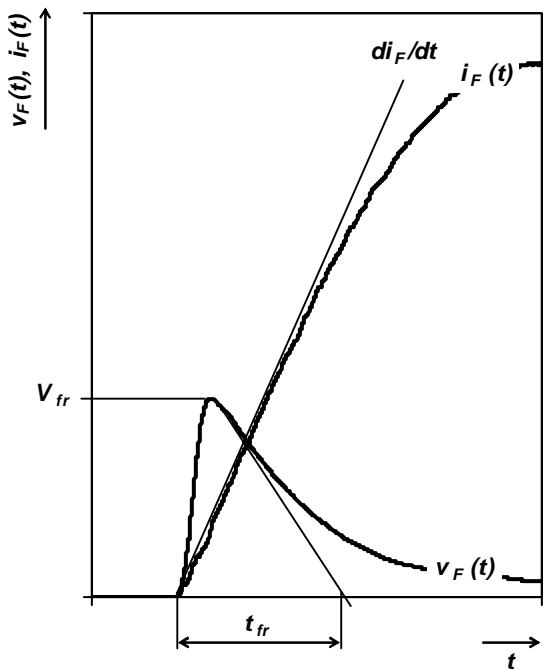


Fig. 10 Typical forward recovery voltage waveform when the diode is turned on with high di_F/dt

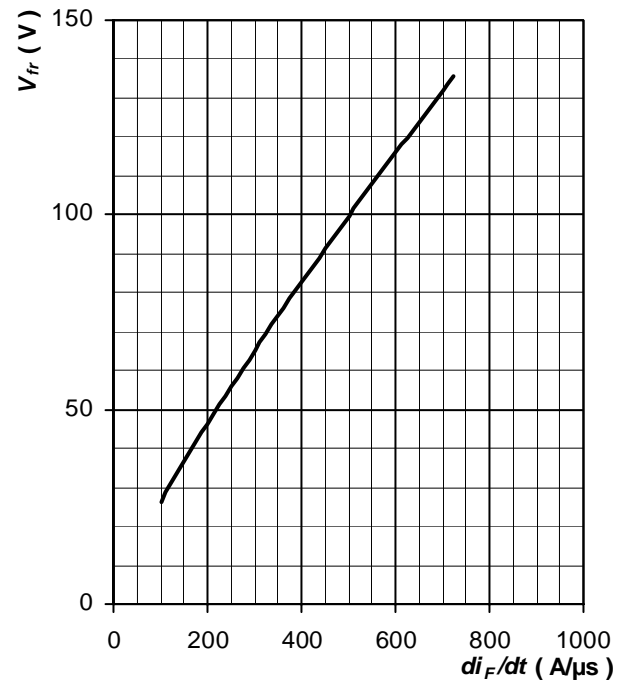


Fig. 11 Max. forward recovery voltage vs. rate of rise of forward current, trapezoid pulse, $T_j = T_{jmax}$, $t_{fr} \leq 10 \mu s$

Reverse Recovery Characteristics

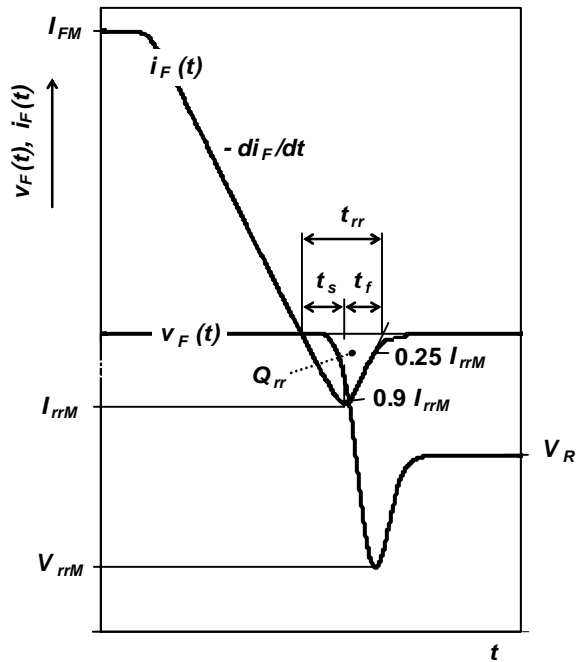


Fig. 12 Typical waveforms and definition of symbols at reverse recovery of a diode, inductive switching without RC snubber

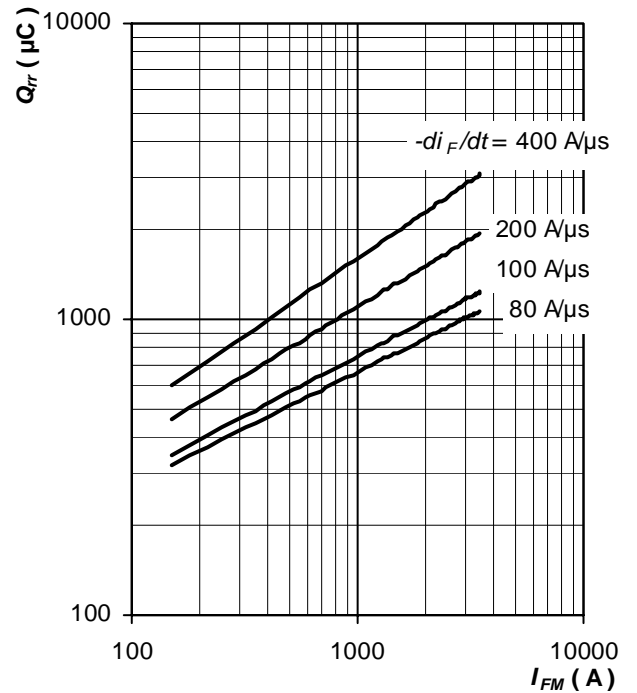


Fig. 13 Max. recovered charge vs. forward current, trapezoid pulse, $T_j = T_{jmax}$

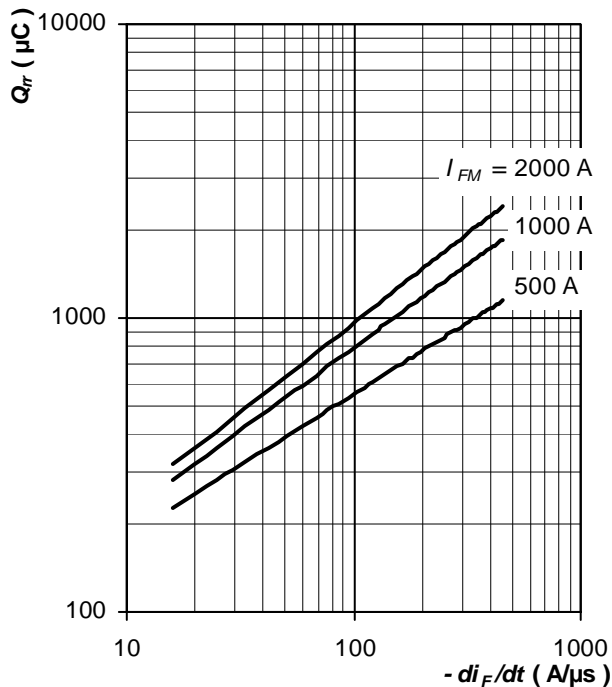


Fig. 14 Max. recovered charge vs. rate of fall of forward current, trapezoid pulse, $T_j = T_{jmax}$

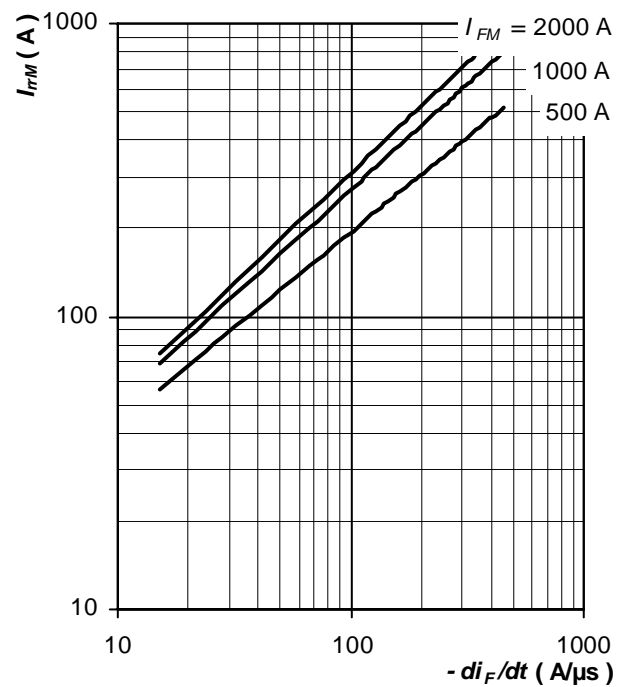


Fig. 15 Max. reverse recovery current vs. rate of fall of forward current, trapezoid pulse, $T_j = T_{jmax}$

Notes:

ABB s.r.o., Novodvorska 1768/138a, 142 21 Praha 4, Czech Republic

ABB s.r.o. reserves the right to change the data contained herein at any time without notice